

4510 Blower Series

Dimensions: 45X45X10 mm

Bearing Type: FDB,Hydraulic,Ball Bearing

Function Type: FG/RD Signal,PWM pulse

Protection: Auto Restart Protection or General Options



SPECIFICATIONS

MODEL NO	VOLTAGE	CURRENT	POWER	SPEED	AIR FLOW		STATIC PRESSURE		NOISE	CURVE
	V	A	W	RPM	CMM	CFM	mmH ₂ O	INH ₂ O	(dBA)	
4510B/RVL-N (P/M) 5	5	0.20	1.00	3000	0.033	1.18	1.87	0.074	18.5	L
4510B/RVM-N (P/M) 5	5	0.30	1.50	4000	0.047	1.67	3.72	0.146	23.7	M
4510B/RVH-N (P/M) 5	5	0.40	2.00	5400	0.063	2.24	6.76	0.266	29.3	H
4510B/RVL-N (P/M) 1	12	0.15	1.80	3000	0.033	1.18	1.87	0.074	18.5	L
4510B/RVM-N (P/M) 1	12	0.25	3.00	4000	0.047	1.67	3.72	0.146	23.7	M
4510B/RVH-N (P/M) 1	12	0.35	4.20	5400	0.063	2.24	6.76	0.266	29.3	H

PERFORMANCE CURVES

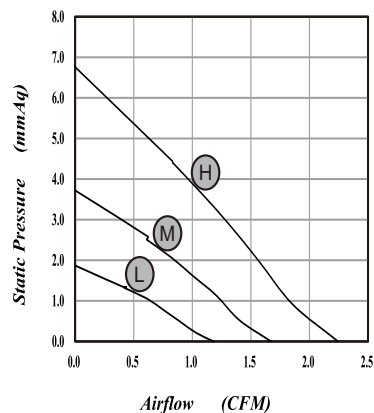

DIMENSIONS DRAWING

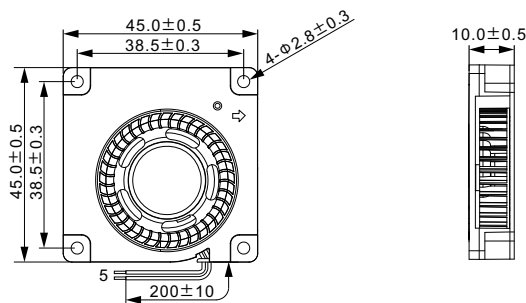

*Specifications are subject to change without notice