

6028 Blower Series

Dimensions: 60X60X28 mm

Bearing Type: FDB,Hydraulic,Ball Bearing

Function Type: FG/RD Signal,PWM pulse

Protection: Auto Restart Protection or General Options



SPECIFICATIONS

MODEL NO	VOLTAGE	CURRENT	POWER	SPEED	AIR FLOW		STATIC PRESSURE		NOISE	CURVE
	V	A	W	RPM	CMM	CFM	mmH ₂ O	INH ₂ O	(dBA)	
6028B/RVL-N (P/M) 1	12	0.30	3.60	2500	0.102	3.59	1.44	0.057	22.0	L
6028B/RVM-N (P/M) 1	12	0.40	4.80	3500	0.146	5.15	3.20	0.126	30.4	M
6028B/RVH-N (P/M) 1	12	0.50	6.00	4500	0.167	6.77	5.88	0.231	41.1	H
6028B/RVL-N (P/M) 2	24	0.15	3.60	2500	0.102	3.59	1.44	0.057	22.0	L
6028B/RVM-N (P/M) 2	24	0.35	6.40	3500	0.146	5.15	3.20	0.126	30.4	M
6028B/RVH-N (P/M) 2	24	0.45	10.80	4500	0.167	6.77	5.88	0.231	41.1	H

PERFORMANCE CURVES

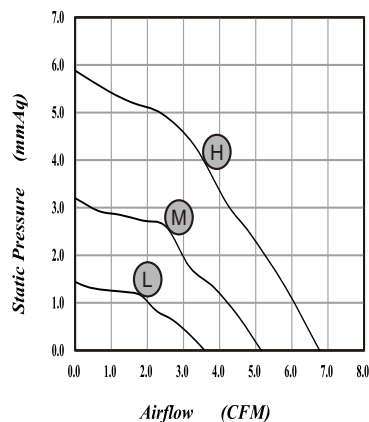

DIMENSIONS DRAWING

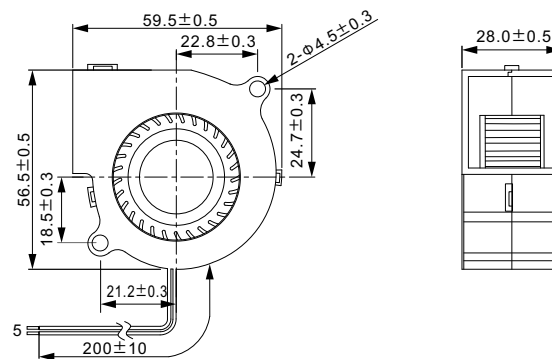

*Specifications are subject to change without notice